

Life
made
easy

LIMIT 600

ELECTROMECHANICAL BARRIER
FOR RESIDENTIAL, INDUSTRIAL
OR PUBLIC USE



LIMIT 600

up to 6m beam

Possibility to install a LED signal light on board

Robust ambidextrous beam support in die-cast aluminium



Possibility to install, along the beam length, beam strip LED for crossing-light version or with white light

Manual key and fold-away emergency release lever

Robust steel frame with protective treatment

Micro-switch and mechanical stop adjustment by one screw

Easily accessible built-in control board for appropriate programming

Spherical self-lubricating eyelet-fixed spring for smoother, wear reducing movement

A single spring is provided which, depending on the length of the beam, is fixed to one of the holes in the spring tensioning arm

Also available in grey RAL 7011 version



Depending on the length of the beam and relative accessories, the AC-541 spring must be fixed to one of the holes of the spring-tightening arm according to the table and diagram below.

SPRING AC-541	SPRING POSITIONING AC-541					SPRING-TIGHTENING ARM
ROD LENGTH	2 m	3 m	4 m	5 m	6 m	
BEAM	1-2 *	1-2-3*	3	3	3	
BEAM WITH PROTECTIVE RUBBER AND LED STRIP LED	1-2 *	3	3	3	3	
BEAM WITH PROTECTIVE RUBBER, STRIP LED AND MOBILE SUPPORT	1-2 *	3	3	3	3	
BEAM WITH PROTECTIVE RUBBER, STRIP LED AND ALUMINUM SKIRT	-	3	3	3	-	
BEAM WITH PROTECTIVE RUBBER, STRIP LED AND ALUMINUM SKIRT AND MOBILE SUPPORT	-	3	3	3	-	

* The SPRING can be fixed in the indicated holes with adequate adjustment for a correct balance of the rod. With the barrier unlocked, the rod must remain in balance at 45°



Every single product is duly tested at the end of each assembly line

TECHNICAL FEATURES

	LIMIT 600 24V
Power supply	230 VAC
Motor power supply	24 VDC
Power consumption	150 W
Current input	6,2 A
Torque	300 Nm
Duty cycle	Intensive use
Protection rating (IP)	IP44
Insulation class	2
Working temperature	-20°C / +50°C

DIMENSIONS (mm)

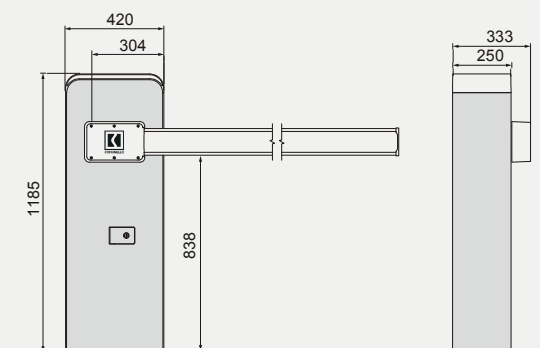

For beams up to 6 m in length

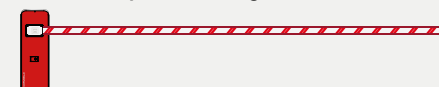

For beams up to 12 m in length (6+6m)





OFFICIAL DEALER:

 **COMUNELLO**
AUTOMATION

AUTOMATION FOR GATES, DOORS AND BARRIERS

FRATELLI COMUNELLO S.P.A.

HEADQUARTERS

Via Zarpellon, 33

36027 San Giuseppe di Cassola, Vicenza, Italy

Tel. +39 0424 585111 Fax +39 0424 533417

info@comunello.it www.comunello.com

REGISTERED OFFICE

Via Cassola,64 - C.P.79







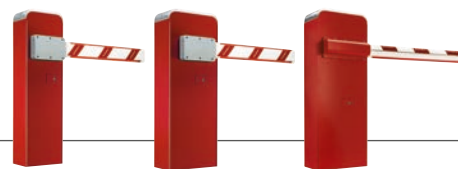







36027 Rosà, Vicenza, Italy

Tel. +39 0424 585111 Fax +39 0424 533417

info@comunello.it www.comunello.com







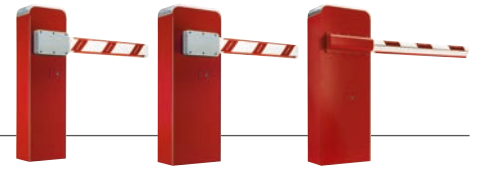



LIMIT Accessories

				Compatible with				
				Limit 500	Limit 600	Limit 800		
	AC-30	Outdoor antenna (cable L = 3m) 433.92 MHz	GANTENNANOG00	•	•	•	1	0,2 kg
	AC-240	Inductive sensor	GINDUCTONOG00	•	•	•	1	0,28 kg
	AC-500	Foundation Kit Border 400/ Limit 500	GLTANCHOROG00	•			1	1,8 Kg
	AC-510	Foundation Kit Limit 600/800	GLTANCHO80G00		•	•	1	2,2 kg
	AC-541	Unified spring for light bar Border/Limit	GLTSPRINGUG00	•	•	•	1	3,8 kg
	AC-550	Doble spring for Limit 800	GLTSPRINGTG00			•	1	7,1 kg
	AC-560R	Arm nesting post for barriers	GLTFIX0000R00	•	•	•	1	4,6 kg
	AC-570	Swing down support for beam	GLTSUPPORTG00	•	•	•	1	1,05 kg
	AC-580	90° jointed rod for barrier	GLTANG9000G00	•	•		1	6,7 kg
	AC-590	Aluminium curtain for barrier, L = 2 m	GLTHEDGE02W00	•	•	•	1	1,7 kg
	AC-630	Aluminium rectangular beam L = 3 m	GLTBAR3001W00	•	•		1	3,5 kg
	AC-640	Aluminium rectangular beam L = 4 m	GLTBAR4001W00	•	•		1	4,7 kg
	AC-650	Aluminium rectangular beam L = 5 m	GLTBAR5001W00	•	•		1	5,90 kg
	AC-655	Aluminium rectangular beam L = 6 m	GLTBAR6001W00	•	•		1	7,00 kg
	AC-731	Aluminium round barrier L = 3 m	GLTBAR8300W00			•	1	3,70 kg
	AC-741	Aluminium round barrier L = 4 m	GLTBAR8400W00			•	1	5,20 kg
	AC-751	Aluminium round barrier L = 5 m	GLTBAR8500W00			•	1	6,50 kg
	AC-765	Round beam joint	GLTJOINTT1G00			•	1	1,10 kg
	AC-775	Rectangular beam joint	GLTJOINTROG00	•	•		1	1,10 kg
	AC-660	Reflective adhesive strips Comunello (pack of 30 pieces)	GLTSTRIP00W00	•	•		1	0,10 kg
	AC-661	Reflective adhesive strips Comunello (pack of 30 pieces) for LIMIT 800	GLTSTRIP01W00			•	1	0,10 kg



LIMIT Accessories

				Compatible with				
				Limit 500	Limit 600	Limit 800		
	AC-670	Red gum cover (upper and bottom), L= 3 m	GLTTOPP301R00	•	•		1	0,62 kg
	AC-681	Red gum cover (upper and bottom), L= 4 m	GLTTOPP401R00	•	•		1	0,85 kg
	AC-682	Red gum cover (upper and bottom), L= 5 m	GLTTOPP501R00	•	•		1	1,60 kg
	AC-683	Red gum cover (upper and bottom), L= 6 m	GLTTOPP601R00	•	•		1	1,71 kg
	AC-684	Red gum cover (bottom), L= 8 m	GLTTOPP801R00			•	1	0,85 kg
	AC-670T	Transparent gum cover (upper and bottom), L= 3 m	GLTTOPP301T00	•	•		1	0,62 kg
	AC-681T	Transparent gum cover (upper and bottom), L= 4 m	GLTTOPP401T00	•	•		1	0,85 kg
	AC-682T	Transparent gum cover (upper and bottom), L= 5 m	GLTTOPP501T00	•	•		1	1,60 kg
	AC-683T	Transparent gum cover (upper and bottom), L= 6 m	GLTTOPP601T00	•	•		1	1,71 kg
	AC-700	Rectangular beam end plug with protection outline	GLTSTOPPERW00	•	•		1	0,01 kg
	AC-710	End plug for rectangular beam with protection gum cover	GBRPLUG011W00	•	•		1	0,06 kg
	AC-715	End plug for rectangular beam without protection gum cover	GLTPLUG021W00	•	•		1	0,03 kg
	AC-713	End plug for round Beam with protection gum cover	GLTPLUG041W00			•	1	0,05 kg
	AC-771	Internal superior LED lights	GLTSWIFTN1G00	•	•	•	1	0,2 kg
	AC-800	Luminous LED strips for beam, L= 5 m	GLTLED5000W00	•	•	•	1	0,4 kg
	AC-778	Luminous RGB LED strips for beam, L= 8 m	GLTLED80T0W00	•	•	•	1	1,10 kg
	TRAFFIC ADAPTER	Traffic light adapter	GTRAFADAPOG00	•	•	•	1	0,2 kg

LIMIT 600 KIT System



24 Vdc electromechanical barrier with encoder, 6 m beam

Limit 600	24 Vdc	GKLTx60EL0R901	CU 24V LT	57,5 kg	6

LT600-24V-B 1 Limit 600 24V	AC-655 Aluminium rectangular beam L = 6 m	AC-660 Reflective adhesive strips Comunello (pack of 30 pieces)	AC-700 Rear covers for rectangular beam with protective rubber	AC-710 Front cap for rectangular beam with protective rubber	AC-510 Foundation kit	AC-541 Unified spring for barreirs Border/ Limit
	AC-800 3 LED strips for beams L = 5 m	AC-771 3 Internal Led lights	AC-570 End bar Swing down support for beam	AC-683 Red protective profile for Limit beam (upper and beam), L = 6 m		

KIT Version available also with splitted beams (3m + 3m and AC-775 Rectangular Beam joint)

Complete 24 Vdc barrier kit with 6 m boom with traffic light function

Kit Limit 600 - 6 m - Traffic light	GKLTx60EL0R907	57,5 kg	6

LT600-24V-B 1 Limit 600 24V	AC-655 Aluminium rectangular beam L = 6 m	AC-660 Reflective adhesive strips Comunello (pack of 30 pieces)	AC-700 Rear covers for rectangular beam with protective rubber	AC-710 Front cap for rectangular beam with protective rubber	AC-510 Foundation kit	
	AC-541 Unified spring for barreirs Border/Limit	AC-778 2 LED strips for beams L = 8 m	AC-771 3 Internal Led lights	AC-570 End bar Swing down support for beam	AC-6813T Transparent gum cover (upper and beam), L = 6 m	TRAFFIC ADAPTER Traffic light adapter

	TRAFFIC LIGHT	
--	----------------------	--

KIT Version available also with splitted beam (3m + 3m and AC-775 Rectangular Beam joint)