

Life
made
easy

LIMIT 800

ELECTROMECHANICAL BARRIER
FOR RESIDENTIAL, INDUSTRIAL
OR PUBLIC USE



LIMIT 800

up to 8m beam

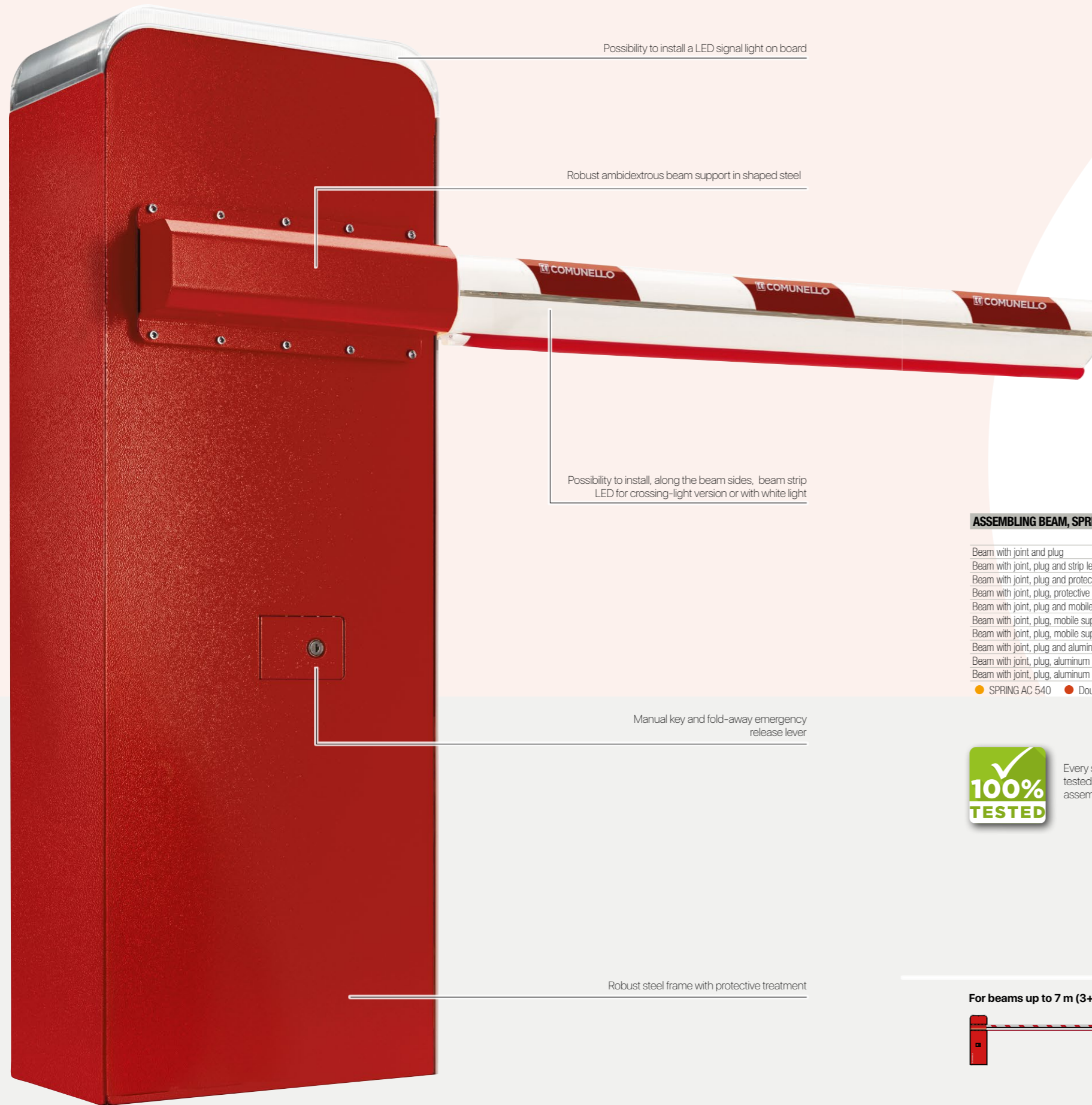

ASSEMBLING BEAM, SPRING CHOICE AND BALANCE

LENGTH

| | 6,00 | 6,50 | 7,00 | 7,50 | 8,00 |
|---|------|------|------|------|------|
| Beam with joint and plug | ● | ● | ● | ● | ● |
| Beam with joint, plug and strip led | ● | ● | ● | ● | ● |
| Beam with joint, plug and protective rubbers | ● | ● | ● | ● | ● |
| Beam with joint, plug, protective rubbers and strip led | ● | ● | ● | ● | ● |
| Beam with joint, plug and mobile support | ● | ● | ● | ● | ● |
| Beam with joint, plug, mobile support and strip led | ● | ● | ● | ● | ● |
| Beam with joint, plug, mobile support, strip led and protective rubbers | ● | ● | ● | ● | ● |
| Beam with joint, plug and aluminum skirt | ● | ● | ● | ● | ● |
| Beam with joint, plug, aluminum skirt and strip led | ● | ● | ● | ● | ● |
| Beam with joint, plug, aluminum skirt, strip led and mobile support | ● | ● | ● | ● | ● |

● SPRING AC 540 ● Double SPRING AC 550



Every single product is duly tested at the end of each assembly line

TECHNICAL FEATURES

| | LIMIT 800 24V |
|------------------------|---------------|
| Power supply | 230 VAC |
| Motor power supply | 24 VDC |
| Power consumption | 150 W |
| Current input | 6,2 A |
| Torque | 300 Nm |
| Duty cycle | Intensive use |
| Protection rating (IP) | IP44 |
| Insulation class | 2 |
| Working temperature | -20°C / +50°C |

DIMENSIONS (mm)

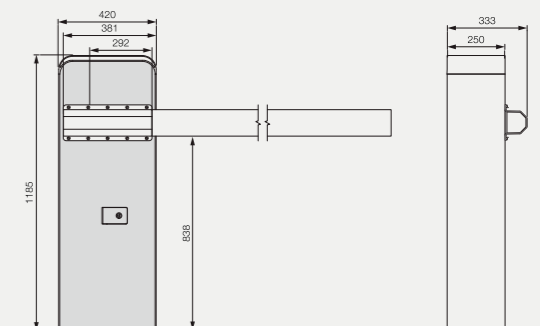

For beams up to 7 m (3+4 m) and up to 8 m (4+4 m)



For beams up to 10/16 m





OFFICIAL DEALER:

COMUNELLO **AUTOMATION**

AUTOMATION FOR GATES, DOORS AND BARRIERS

FRATELLI COMUNELLO S.P.A.

HEADQUARTERS

Via Zarpellon, 33

36027 San Giuseppe di Cassola, Vicenza, Italy

Tel. +39 0424 585111 Fax +39 0424 533417

info@comunello.it www.comunello.com

REGISTERED OFFICE

Via Cassola,64 - C.P.79







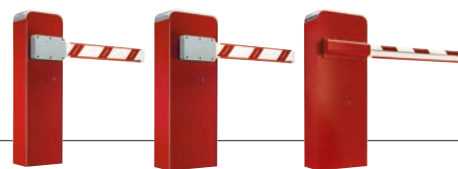







36027 Rosà, Vicenza, Italy

Tel. +39 0424 585111 Fax +39 0424 533417

info@comunello.it www.comunello.com













LIMIT Accessories

| | | | | Compatible with | | | | |
|---|----------------|---|---------------|-----------------|-----------|-----------|---|---------|
| | | | | Limit 500 | Limit 600 | Limit 800 | | |
|  | AC-30 | Outdoor antenna (cable L = 3m) 433.92 MHz | GANTENNANOG00 | • | • | • | 1 | 0,2 kg |
|  | AC-240 | Inductive sensor | GINDUCTONOG00 | • | • | • | 1 | 0,28 kg |
|  | AC-500 | Foundation Kit Border 400/ Limit 500 | GLTANCHOROG00 | • | | | 1 | 1,8 Kg |
|  | AC-510 | Foundation Kit Limit 600/800 | GLTANCHO80G00 | | • | • | 1 | 2,2 kg |
|  | AC-541 | Unified spring for light bar Border/Limit | GLTSPRINGUG00 | • | • | • | 1 | 3,8 kg |
|  | AC-550 | Doble spring for Limit 800 | GLTSPRINGTG00 | | | • | 1 | 7,1 kg |
|  | AC-560R | Arm nesting post for barriers | GLTFIX0000R00 | • | • | • | 1 | 4,6 kg |
|  | AC-570 | Swing down support for beam | GLTSUPPORTG00 | • | • | • | 1 | 1,05 kg |
|  | AC-580 | 90° jointed rod for barrier | GLTANG9000G00 | • | • | | 1 | 6,7 kg |
|  | AC-590 | Aluminium curtain for barrier, L = 2 m | GLTHEDGE02W00 | • | • | • | 1 | 1,7 kg |
|  | AC-630 | Aluminium rectangular beam L = 3 m | GLTBAR3001W00 | • | • | | 1 | 3,5 kg |
| | AC-640 | Aluminium rectangular beam L = 4 m | GLTBAR4001W00 | • | • | | 1 | 4,7 kg |
| | AC-650 | Aluminium rectangular beam L = 5 m | GLTBAR5001W00 | • | • | | 1 | 5,90 kg |
| | AC-655 | Aluminium rectangular beam L = 6 m | GLTBAR6001W00 | • | • | | 1 | 7,00 kg |
|  | AC-731 | Aluminium round barrier L = 3 m | GLTBAR8300W00 | | | • | 1 | 3,70 kg |
| | AC-741 | Aluminium round barrier L = 4 m | GLTBAR8400W00 | | | • | 1 | 5,20 kg |
| | AC-751 | Aluminium round barrier L = 5 m | GLTBAR8500W00 | | | • | 1 | 6,50 kg |
|  | AC-765 | Round beam joint | GLTJOINTT1G00 | | | • | 1 | 1,10 kg |
| | AC-775 | Rectangular beam joint | GLTJOINTROG00 | • | • | | 1 | 1,10 kg |
|  | AC-660 | Reflective adhesive strips Comunello (pack of 30 pieces) | GLTSTRIP00W00 | • | • | | 1 | 0,10 kg |
|  | AC-661 | Reflective adhesive strips Comunello (pack of 30 pieces) for LIMIT 800 | GLTSTRIP01W00 | | | • | 1 | 0,10 kg |



LIMIT Accessories

| | | | | Compatible with | | | | |
|---|------------------------|--|---------------|-----------------|-----------|-----------|---|---------|
| | | | | Limit 500 | Limit 600 | Limit 800 | | |
|  | AC-670 | Red gum cover (upper and bottom), L= 3 m | GLTTOPP301R00 | • | • | | 1 | 0,62 kg |
| | AC-681 | Red gum cover (upper and bottom), L= 4 m | GLTTOPP401R00 | • | • | | 1 | 0,85 kg |
| | AC-682 | Red gum cover (upper and bottom), L= 5 m | GLTTOPP501R00 | • | • | | 1 | 1,60 kg |
| | AC-683 | Red gum cover (upper and bottom), L= 6 m | GLTTOPP601R00 | • | • | | 1 | 1,71 kg |
|  | AC-684 | Red gum cover (bottom), L= 8 m | GLTTOPP801R00 | | | • | 1 | 0,85 kg |
|  | AC-670T | Transparent gum cover (upper and bottom), L= 3 m | GLTTOPP301T00 | • | • | | 1 | 0,62 kg |
| | AC-681T | Transparent gum cover (upper and bottom), L= 4 m | GLTTOPP401T00 | • | • | | 1 | 0,85 kg |
| | AC-682T | Transparent gum cover (upper and bottom), L= 5 m | GLTTOPP501T00 | • | • | | 1 | 1,60 kg |
| | AC-683T | Transparent gum cover (upper and bottom), L= 6 m | GLTTOPP601T00 | • | • | | 1 | 1,71 kg |
|  | AC-700 | Rectangular beam end plug with protection outline | GLTSTOPPERW00 | • | • | | 1 | 0,01 kg |
|  | AC-710 | End plug for rectangular beam with protection gum cover | GBRPLUG011W00 | • | • | | 1 | 0,06 kg |
|  | AC-715 | End plug for rectangular beam without protection gum cover | GLTPLUG021W00 | • | • | | 1 | 0,03 kg |
|  | AC-713 | End plug for round Beam with protection gum cover | GLTPLUG041W00 | | | • | 1 | 0,05 kg |
|  | AC-771 | Internal superior LED lights | GLTSWIFTN1G00 | • | • | • | 1 | 0,2 kg |
|  | AC-800 | Luminous LED strips for beam, L= 5 m | GLTLED5000W00 | • | • | • | 1 | 0,4 kg |
|  | AC-778 | Luminous RGB LED strips for beam, L= 8 m | GLTLED80T0W00 | • | • | • | 1 | 1,10 kg |
|  | TRAFFIC ADAPTER | Traffic light adapter | GTRAFADAPOG00 | • | • | • | 1 | 0,2 kg |

LIMIT 800 KIT System



Complete 24 Vdc barrier kit up to 8 m boom with traffic light function

| Kit Limit 800 - 8 m - Traffic light | GKLT080EL0R907 | 122 kg | 6 |
|--|----------------|--------|---|

| | | | | | | |
|---|--|--|--|---|---|---|
| LT800-24V-B 1 Limit 600 24V | AC-731 Aluminium round beam with transparent side sheaths, L = 3 m | AC-751 Aluminium round beam with transparent side sheaths, L = 5 m | AC-765 Round beam joint | AC-661 Reflective adhesive strips Comunello for Limit 800 (pack of 30 pieces) | AC-713 Front cap for round beam without protective rubber | AC-778 2 RGB LED strips for beams L = 8 m |
| AC-510 Foundation kit | AC-550 Double spring for Limit 800 | AC-771 3 Internal LED lights | AC-570 End bar swing down support for beam | AC-684 Red protective profile for Limit round beam, L = 8 m | TRAFFIC ADAPTER Traffic light adapter | |

TRAFFIC LIGHT

8 m

