

RAM

SWING GATES ACTUATOR
VERSIONS 230V AND 24V

Life
made
easy



RAM

Technical features



Every single product is duly tested at the end of each assembly line

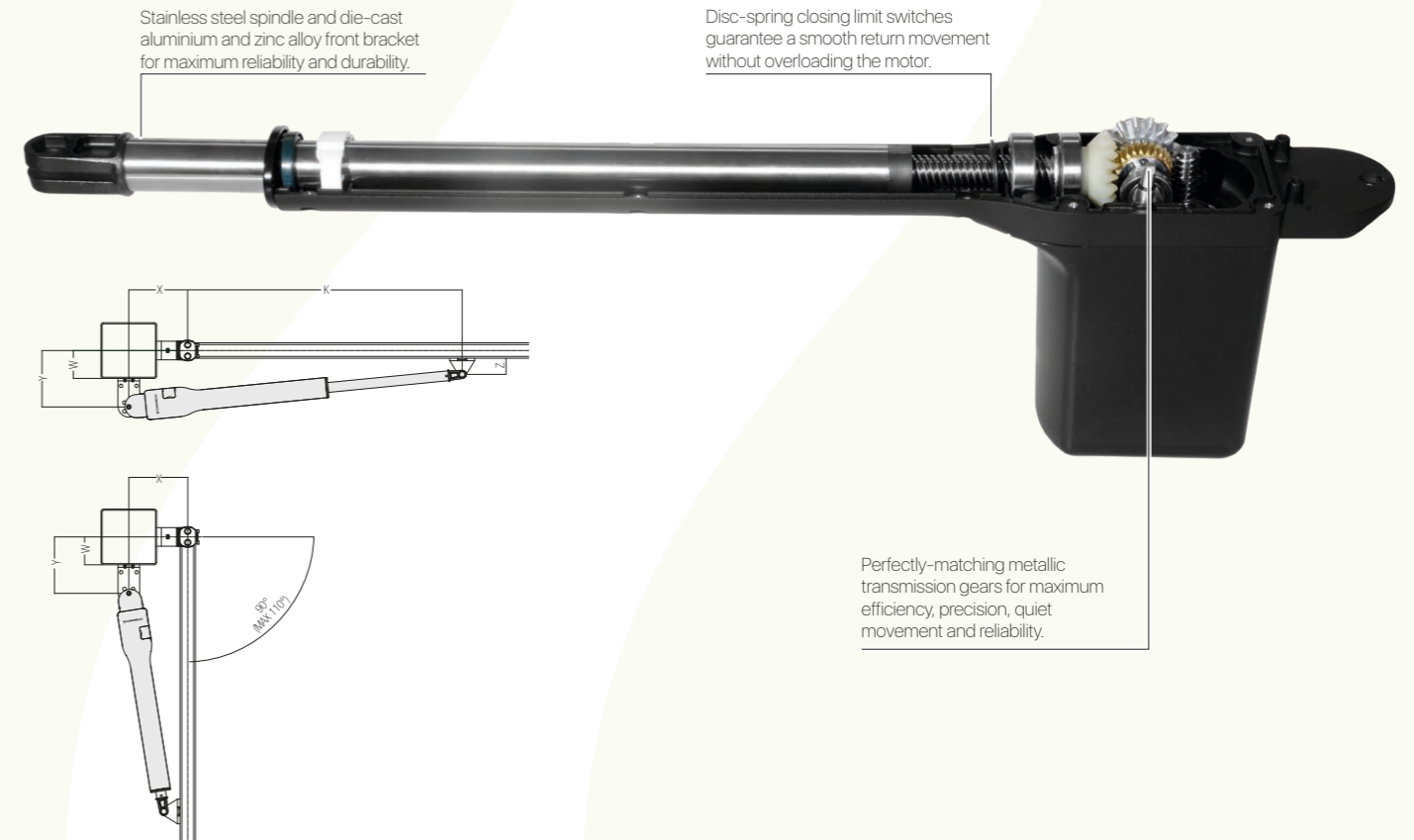

OPERATING LIMITS RAM 220/300

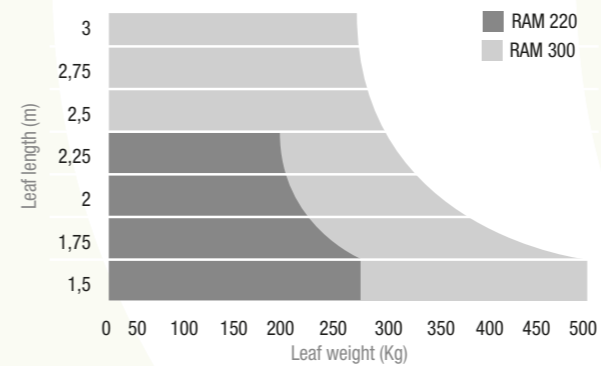

OPERATING LIMITS RAM 500

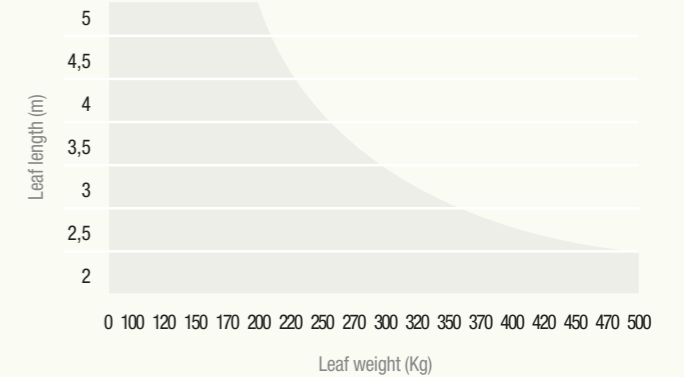

DIMENSIONS (mm)

ambidextrous

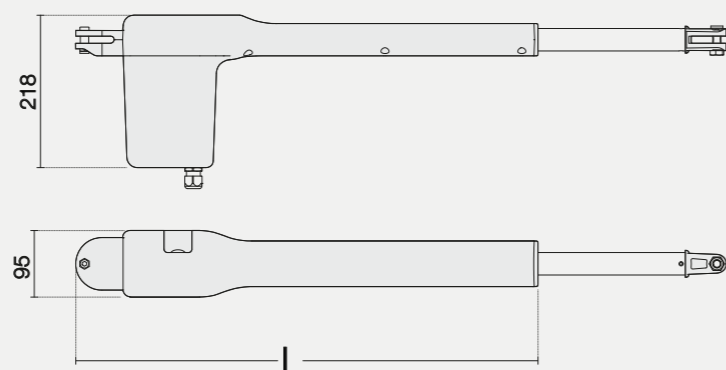

Technical features

	RAM 220 24V	RAM 300 24V	RAM 300 230V	RAM 500 24V	RAM 500 230V
Voltage	24 VDC	24 VDC	230 VAC	24 VDC	230 VAC
Power consumption	60 W	100 W	280 W	100 W	280 W
Max. absorption	3 A	5 A	1,2 A	5 A	1,2 A
Max. thrust	1500 N	2000 N	1800 N	1800 N	2000 N
Standard stroke	374 mm	374 mm	374 mm	524 mm	524 mm
Duty cycle	Intensive use	Intensive use	40%	Intensive use	30%
Protection degree (IP)	IP44	IP44	IP44	IP44	IP44
Insulation class	2	2	1 (earthing)	2	1 (earthing)
Working temperature	-20°C / +50°C	-20°C / +50°C	-20°C / +50°C	-20°C / +50°C	-20°C / +50°C
No-load speed	18 mm/s	21 mm/s	16 mm/s	22 mm/s	15 mm/s
Weight	7 kg	7,8 kg	8,3 kg	8,8 kg	9,3 kg



OFFICIAL DEALER:

 **COMUNELLO**
AUTOMATION

AUTOMATION FOR GATES, DOORS AND BARRIERS

FRATELLI COMUNELLO S.P.A.

HEADQUARTERS

Via Zarpellon, 33

36027 San Giuseppe di Cassola, Vicenza, Italy

Tel. +39 0424 585111 Fax +39 0424 533417

info@comunello.it www.comunello.com

REGISTERED OFFICE

Via Cassola,64 - C.P.79

36027 Rosà, Vicenza, Italy















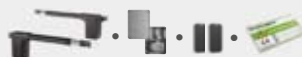

Tel. +39 0424 585111 Fax +39 0424 533417

info@comunello.it www.comunello.com

RAM KIT System



24V Complete kits with telescopic rod actuators for swinging gates, 24 Vdc, up to 5 m length

	KIT System				
	ENTRY 	GKRM220HLB930	QUAD 24V HP	17,9 kg	16
 RAM 220	LIGHT 	GKRM220HLB920	QUAD 24V HP	18,1 kg	16
	FULL 	GKRM220HLB900	QUAD 24V HP	18,3 kg	16
	ENTRY 	GKRM300HLB930	QUAD 24V HP	19,5 kg	16
 RAM 300	LIGHT 	GKRM300HLB920	QUAD 24V HP	19,7 kg	16
	FULL 	GKRM300HLB900	QUAD 24V HP	19,9 kg	16
	ENTRY 	GKRM500HLB930	QUAD 24V HP	21,5 kg	16
 RAM 500	LIGHT 	GKRM500HLB920	QUAD 24V HP	21,7 kg	16
	FULL 	GKRM500HLB900	QUAD 24V HP	21,9 kg	16

RAM KIT System



230V Complete kits with telescopic rod actuators for swinging gates, 230 Vac, up to 5 m length

	KIT System				
 RAM 300	ENTRY	GKRM300HHB930	QUAD 230V HP	19,5 kg	16
	LIGHT	GKRM300HHB920	QUAD 230V HP	19,7 kg	16
	FULL	GKRM300HHB900	QUAD 230V HP	19,9 kg	16
 RAM 500	ENTRY	GKRM500HHB930	QUAD 230V HP	21,0 kg	16
	LIGHT	GKRM500HHB920	QUAD 230V HP	21,2 kg	16
	FULL	GKRM500HHB900	QUAD 230V HP	21,4 kg	16